

KEURIG[®]
COMMERCIAL

K-1500[™]

Use & Care Guide

Get the most from your
new Keurig[®] brewer

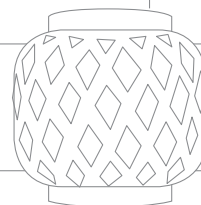
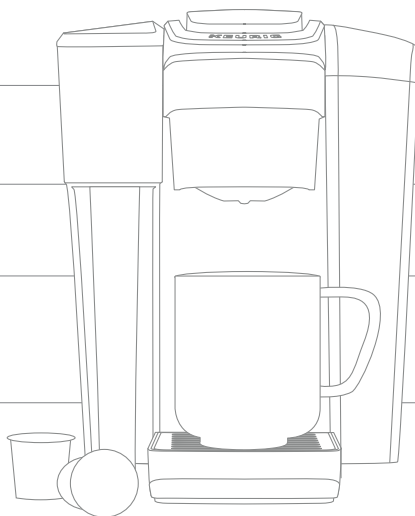

Before You Brew

1 Plug & Place

Remove packing tape from brewer and plug into a grounded outlet.

Place a large mug (12oz minimum) on the drip tray plate.

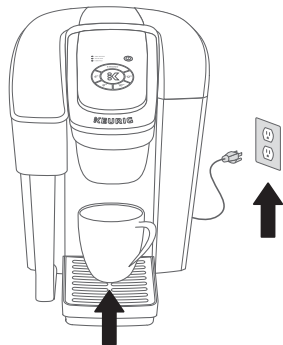

2 Rinse & Fill

Remove the water reservoir lid, then lift the reservoir straight up to remove it.

Rinse reservoir with fresh water and fill to the **MAX** fill line.

Replace water reservoir, making sure the lock tab engages with the brewer. Replace lid.

NOTE: Do not use distilled water.

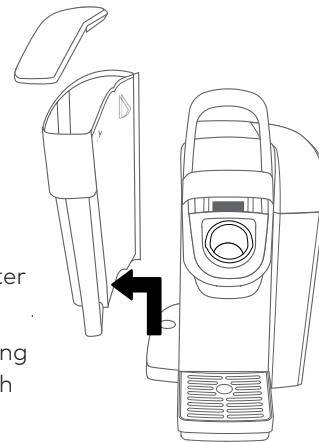

3 Power On

Press power button — the white power light will illuminate.

The brewer will automatically begin heating the water. This will take about 3 minutes. Once the heating sound stops, the brewer is ready.

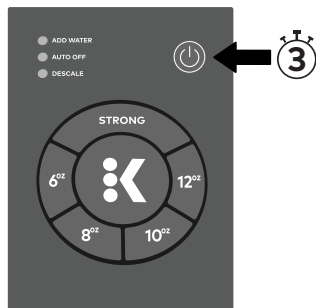

4 Cleansing Brew

Do not insert a K-Cup® pod.

Open and close the bail. The brew size and **STRONG** buttons will blink. Press the 8oz button and then the Brew button to start a cleansing brew. Pour the hot water into the sink.

The one-time setup process is now complete and you are ready to brew!

NOTE: Between brew cycles, the brewer may take about a minute to reheat.

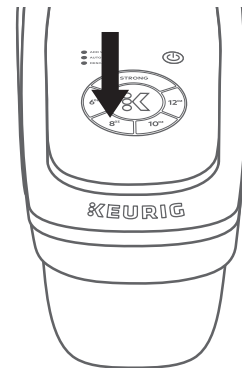

Brew Your First Cup

5 Place Mug

Place a mug on the drip tray plate. If using a travel mug, remove the drip tray and place the mug on the drip tray base.

NOTE: Between brew cycles, the brewer may take about a minute to reheat.

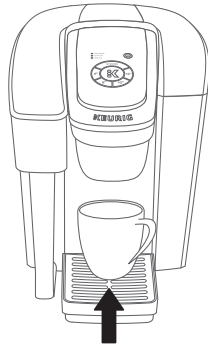

7 Brew & Enjoy!

Select your brew size — for bolder coffee, press the **STRONG** button first. After selecting your brew size the BREW button will flash. Press the brew button to begin brewing your beverage. The brew size, brew button, and STRONG button, if selected, will remain illuminated while brewing — about 1 minute. The brewer will be ready to brew another cup in about a minute.

CAUTION: While brewing, there is extremely hot water in the K-Cup® pod holder. To avoid injury, do not lift the handle during the brewing process.

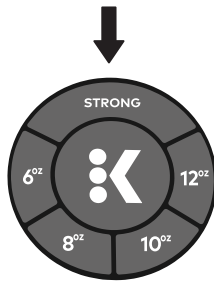

6 Lift & Insert

Lift the handle and place a K-Cup® pod in the K-Cup® pod holder. Lower the handle completely to close the lid. **Do not remove the foil lid on the K-Cup® pod.**

High Altitude Brewing:

When brewing in higher altitudes (5,000 feet), please follow these brewing instructions and enable the High Altitude Brewing Mode on your brewer.

High Altitude Brewing Instructions

1. Power the brewer off while it is plugged in.
2. Press and hold the STRONG and 8oz buttons for 3 seconds – both lights will blink 3 times to confirm that the High Altitude Brewing Mode has been enabled.
3. While holding the brewer bail up, push down slowly on the K-Cup® pod in the pod holder until the bottom of the K-Cup® pod is punctured by the exit needle.

Disable High Altitude Brewing:

1. Power the brewer off while it is plugged in.
2. Press and hold the STRONG and 8oz buttons until the lights are no longer illuminated.

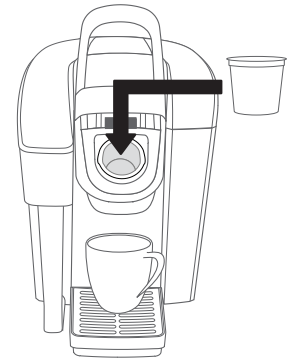

Brewer Features

Strong Brew increases the strength and bold taste of your coffee's flavor. For bolder coffee, press the **STRONG** button and select your brew size.

Smart Start heats then brews in one simple process. No need to wait for the brewer to heat before selecting your brew size. Power on your brewer, place mug, insert a K-Cup® pod, and lower the bail. Then, select your brew size and press the brew button. The brewer will heat, then automatically begin brewing.

Caring for your Brewer

Regular cleaning keeps your brewer running smoothly. Always be sure to turn off and unplug your brewer before cleaning.

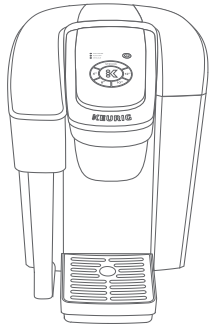

Brewer Exterior

Keep your Keurig® brewer looking its best by cleaning the exterior from time to time. Just clean with a damp, soapy, lint-free, non-abrasive cloth. Never immerse the brewer in water or other liquids.

Drip Tray

The drip tray can accumulate up to 8 ounces of overflow and should be emptied and cleaned occasionally. To remove, slide it toward you, keeping it level to avoid spilling. Clean with a damp, soapy, lint-free, non-abrasive cloth.

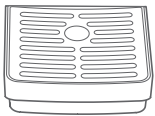

Auto Off automatically turns your brewer off 2 hours after the last brew for energy savings. To disable, power the brewer off while it is still plugged in. Press down on the STRONG and 10oz buttons at the same time and hold for 3 seconds until the AUTO OFF Indicator is turned off. Repeat the same steps to enable the feature.

Commercial Rating ensures that the K-1500™ brewer will stand-up to the demands of your coffee station. Enjoy the convenience of a modern touch-button interface, an industrialized (96oz) water reservoir - with easy-grip handles, and drainable internal hot water tank.

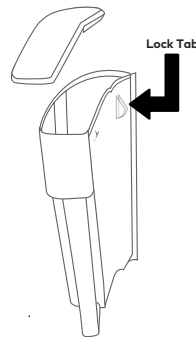

Water Reservoir & Reservoir Lid

The water reservoir lid and water reservoir should be periodically cleaned with a damp, soapy, non-abrasive cloth and rinsed thoroughly. The water reservoir lid and water reservoir should not be put into the dishwasher. Do not dry the inside of the water reservoir with a cloth as lint may remain.

To clean the filter screen at the base of your water reservoir, empty the water reservoir and follow one or all of the following procedures:

NOTE: If you are using a water filter inside the water reservoir, remove it before cleaning.

- Fill the water reservoir with approximately two inches of clean water and agitate (shake) the water reservoir.
- Empty the water reservoir, fill with clean water, and return it to the brewer. If needed, repeat above procedures.

CAUTION: Please rinse the water reservoir thoroughly after cleaning. This will ensure that no cleaners or cleaning solutions remain in this area as they may contaminate the water supply in the brewer.

Caring for your Brewer (continued)

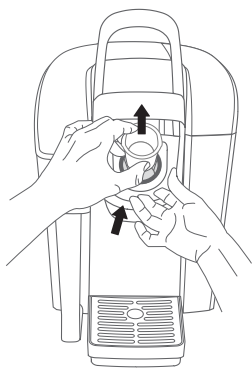

K-Cup® Pod Holder Assembly

To remove the K-Cup® pod holder from the brewer, lift the handle and grasp the top of the K-Cup® pod holder with one hand while pushing up on the bottom of the K-Cup® pod holder from underneath with the other until it releases. To reinstall, align the K-Cup® pod holder with the opening using the two front ribs as a guide and snap into place from the top.

CAUTION: There are sharp needles that puncture the K-Cup® pod above the K-Cup® pod holder and in the bottom of the K-Cup® pod holder. To avoid risk of injury, do not put your fingers in the K-Cup® pod holder.

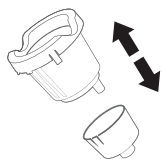

Funnel

The funnel can be removed from the K-Cup® pod holder by pulling on it until it pops off. To replace it, orient the snaps to the indent and just snap it back onto the K-Cup® pod holder.

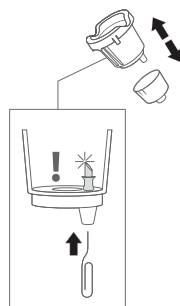

Exit Needle

Remove the pod holder assembly and detach the funnel. Locate the exit needle on the inside bottom of the K-Cup® pod holder. Insert a straightened paper clip into the exit needle to loosen the clog and push it out.

Entrance Needle

Lift the brewer handle and locate the entrance needle on the underside of the brewer head. To clean all three holes in the needle, hold the brewer handle in the upward position and with your other hand, carefully insert a straightened paper clip into all three holes. Gently move it around to loosen any coffee grounds. Lower the handle completely and run two water-only brew cycles. Do not insert a K-Cup® pod.

TIP: Refer to support.keurig.com for video instructions on cleaning the entrance/exit needles.

Descaling your Brewer

You should descale your brewer every 3-6 months or after 500 brew cycles. Properly follow the descaling procedure.

Depending on the mineral content of your water, calcium deposits or scale may build up in your brewer. Scale is non-toxic but if left unattended can hinder brewer performance. Regularly descaling your brewer every 3-6 months helps maintain the heating element, and other internal parts that come in contact with water. Calcium deposits may build up faster, making it necessary to descale more often.

Descaling Procedure

Before you begin, you will need a large ceramic mug, fresh water, Keurig® Descaling Solution, and access to a sink. Do not use a paper cup. Ensure that there is no beverage pod in the K-Cup® pod holder. Disable the "Auto Off" feature on your brewer. Please allow approximately 35 minutes for the descaling procedure.

Empty the water from the water reservoir.
If using a Keurig® Water Filter, remove and set aside.

STEP 1: Descaling Solution Rinse

Press the power button to power the brewer off.

Pour the entire bottle of Keurig® Descaling Solution into an emptied water reservoir. Then fill the empty bottle with water and pour into the water reservoir. Press the power button to turn the brewer back on.

Place a large mug on the drip tray and run a rinsing brew by selecting the largest brew size.

STEP 2: Descaling Rinse & Repeat

Repeat the rinsing brew process until the add water light is illuminated. Do not use a K-Cup® pod. Let brewer stand for at least 30 minutes while still on.

After 30 minutes, discard any residual solution from the water reservoir and rinse thoroughly.

STEP 3: Fresh Water Rinse

Fill the water reservoir with fresh water to and not beyond the MAX fill line.

Place a large mug on the drip tray plate and run a rinsing brew using the largest brew size. Do not use a K-Cup® pod. Pour the contents of the mug into the sink.

Repeat brew process until you have completed at least 12 rinsing brews using the largest brew size. You may need to refill the water reservoir at least one time during this process.

NOTE: The cleaning action of Keurig® Descaling Solution may result in a "foam" dispensed from the brewer. This is natural, as the solution is reacting with the scale inside. For a brewer that is heavily scaled, the brewer may not fill properly after the descaler is added. If this occurs, you may see only a small or no output dispensed, followed by the sound of air blowing out. If this occurs:

- Turn off and unplug the brewer.
- If there is Keurig® Descaling Solution in the water reservoir, discard the contents, rinse the water reservoir thoroughly and refill with water.
- Plug the brewer back in, power on, and repeat the Step 3 Fresh Water Rinse cycle. The brewer should begin to function normally as the solution is rinsed out and the scale is removed. If problem persists, allow brewer to sit unplugged for at least 30 minutes before continuing with the rinse.

Draining the Brewer

The hot water tank of these brewers can be completely drained. We recommend that the brewer be drained if it is to be transported or stored for an extended period of time.

1. Turn off the brewer, unplug it, and allow the brewer to cool approximately 90 minutes.
2. Remove and empty the water reservoir.
3. Turn the brewer around so the back is facing a sink or an area where the water will be drained.
4. Remove the door on the back of the brewer by pressing down on the door clip.
5. Remove the drain tube from within the compartment and carefully remove the plug from the end of the tube while pitching the tubing and pointing it towards the sink or larger pitcher (18oz or larger).
6. Over a sink or large pitcher, drain the water from the internal hot water tank into the pitcher.

CAUTION: If the brewer was not allowed to cool sufficiently, the water draining from the tube may be very hot.

7. Re-cap the tube.

NOTE: To avoid losing parts, when finished, re-insert the tube and close the panel door.

Backside of Brewer (drain line access)

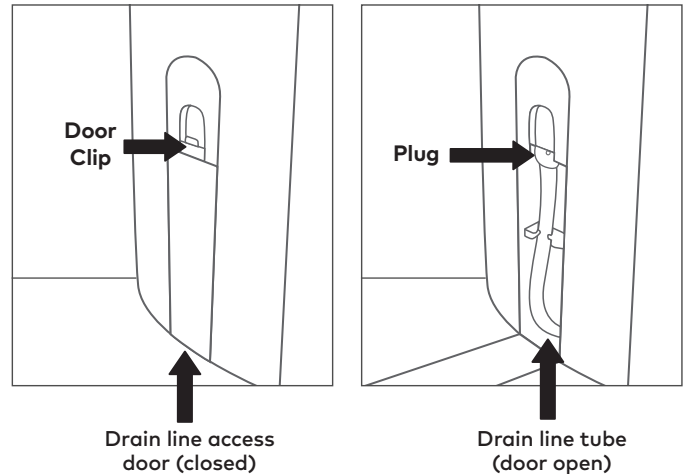

Troubleshooting

Grounds in Your Coffee

- Grounds may have gathered in the exit or entrance needle and can be cleaned using a straightened paper clip or similar tool.
- Clean the exit needle of the K-Cup® pod holder. Refer to the exit needle care instructions.
- Clean the brewer entrance needle. Refer to the entrance needle care instructions.

Brewer Will Not Brew

- After placing the K-Cup® pod in the K-Cup® pod holder, make sure that the handle is pushed down securely and the brew buttons are flashing.
- If the add water light is illuminated, add water to water reservoir. Fill to and not beyond the MAX fill line. Make sure the water reservoir is seated properly in its base. If the add water light continues to be illuminated even after refilling, contact Customer Service.
- If 6, 8, 10, 12oz, and STRONG button lights are all on simultaneously, lift handle and remove K-Cup® pod (if present in the brewer). Close handle and place a large mug on the drip tray. Press the power button once. The brewer may dispense hot water.
- If 6, 8, 10, 12oz lights all blink simultaneously, contact Customer Service.

Brewing a Partial Cup

- The exit needle may be clogged. Refer to the exit needle care instructions.
- The water reservoir may have been removed during brewing. Replace the water reservoir and perform a rinsing brew without a K-Cup® pod.
- The brewer may need to be descaled. If you have repeated the descale procedure on your brewer two times and it is still only brewing a partial cup, contact Customer Service.

Brewer Does Not Have Power or Shuts Off

- Make sure that the power button has been turned on.
- Plug brewer into its own grounded outlet. If the electric circuit is overloaded with other appliances, your brewer may not function properly. The brewer should be operated on its own circuit, separate from other appliances.
- For energy savings, the Factory sets the brewer to turn off automatically after 2 hours of idle time. You can disable this feature by pressing down on the STRONG and 10oz buttons at the same time and holding until the LEDs flash. The AUTO OFF indicator should then turn off. Repeat the same steps to enable the feature. Press the power button and the green power light will illuminate.
- If the brewer still doesn't have power, contact Customer Service.

Helpful Hints

Water quality varies greatly. If you notice an undesirable taste in your beverage (such as chlorine or mineral tastes), we recommend using bottled or filtered water. Do not use distilled water.

Service

Beyond these recommended cleaning and maintenance procedures, this brewer is not user serviceable. For service, please refer to the Warranty section of this guide.

Storage

Empty the water reservoir before storing or transporting and take care to ensure that you store your brewer in a safe and frost free environment. Please be sure to store your brewer in its upright position to avoid water leakage from the inner tank. If you store the brewer in a cold environment, you run the risk of water freezing inside the brewer and causing damage. When you prepare to use it after storage, we recommend rinsing the water reservoir with fresh water and running three rinsing brews without a K-Cup® pod.

If you plan to move your brewer to a different location, turn the brewer off, unplug it, and empty the water reservoir. If your brewer has been in an environment below freezing, please be sure to let it warm to room temperature for at least 2 hours before using.

Click or Call!

Have Questions?

We're here to help. Visit [commercial.Keurig.com](https://www.commercial.Keurig.com) for step-by-step videos on cleaning, descaling, and more.



Still Need Help?

Give us a call at
1-866-901-BREW (2739)

Warranty

LIMITED ONE-YEAR WARRANTY

Keurig Green Mountain, Inc. warrants to the original purchaser that its brewer will be free of defects in materials or workmanship under normal use for one-year from the date of purchase. Keurig, a Keurig Authorized Distributor or Service Agent will, at their option, repair or replace a defective brewer or brewer parts under this warranty without charge upon its receipt of proof of the date of purchase. If a replacement brewer is necessary to service this warranty, the replacement brewer may be new or reconditioned. If a replacement brewer or parts are sent, a new limited one-year warranty will be applied to the replacement brewer or parts. This warranty only applies to brewers operated in the United States and Canada. This warranty gives the original purchaser specific legal rights, and you may also have other rights that vary from state to state and, in the case of Canada, from province to province. If you obtained this brewer through sale or rental from a Keurig Authorized Distributor, you may also want to refer to your distributor's warranty policies. Only the use of Keurig® K-Cup® brand pods and accessories will guarantee the proper functioning and lifetime of a Keurig® K-Cup® brewer. Any damage to or malfunction of your brewer resulting from the use of non Keurig® K-Cup® brand pods and accessories may not be covered by this warranty or may result in a service fee if the damage or malfunction is determined to be caused by such use.

WHAT IS NOT COVERED BY THE LIMITED WARRANTY?

THIS WARRANTY DOES NOT COVER CONSEQUENTIAL OR INCIDENTAL DAMAGES SUCH AS PROPERTY DAMAGE AND DOES NOT COVER INCIDENTAL COSTS AND EXPENSES RESULTING FROM ANY BREACH OF THIS WARRANTY, EVEN IF FORESEEABLE. Some states or provinces do not allow the exclusion or limitations of incidental or consequential damages, so the above limitation

or exclusion may not apply to you depending on the state or province of purchase. Nor does this warranty cover damages caused by use of non Keurig® K-Cup® brand pods or accessories, services performed by anyone other than Keurig or its authorized service providers, use of parts other than genuine Keurig parts, or external causes such as abuse, misuse, inappropriate power supply, or acts of God.

OTHER LIMITATIONS

THIS WARRANTY IS EXCLUSIVE AND IS IN LIEU OF ANY OTHER EXPRESS WARRANTY, WHETHER WRITTEN OR ORAL. IN ADDITION, KEURIG HEREBY SPECIFICALLY DISCLAIMS ALL OTHER WARRANTIES WITH RESPECT TO YOUR K-1500 BREWER, INCLUDING ANY IMPLIED WARRANTY OF MERCHANTABILITY OR FITNESS FOR ANY PARTICULAR PURPOSE. Some states or provinces do not allow disclaimers of such implied warranties or limitations on how long an implied warranty lasts, so the above limitation may not apply to you depending on the state or the province of purchase.

HOW DO YOU OBTAIN WARRANTY SERVICE?

Keurig® brewers are high-quality appliances and, with proper care, are intended to provide years of satisfying performance. However, should the need arise for warranty servicing; simply call your Keurig Authorized Distributor (KAD) who originally sold you the brewer or your Keurig Authorized Service Provider (KASP) for full support. To be re-connected with your KAD or KASP, please call Keurig at 1.888.287.2739 ex.5. If in Canada, please call: 1.800.361.5628. Keurig Green Mountain, Inc. 33 Coffee Lane Waterbury, VT 05676

K-1500™ COFFEE MAKER

- A. Water Reservoir Lid
- B. MAX Fill Line
- C. Water Reservoir
- D. Water Reservoir Lock Tab Slot
- E. Water Reservoir Handle
- F. Power Cord
- G. Bail
- H. Lid
- I. K-Cup® Pod Holder (H and I are the K-Cup® Pod Holder Assembly)
- J. Funnel
- K. K-Cup® Pod Assembly Housing
- L. Drip Tray Plate
- M. Drip Tray
- N. Drip Tray Base

